



上海厂区：上海市嘉定区黄渡工业区春意路111号
Add: No.111, Chunyi Rd, Huangdu Industrial Zone, Shanghai

常州厂区：江苏省常州市溧阳溧城镇上上路118号
Add: No.118,shangshang Road,Licheng Town,Liyang,Changzhou city



电话 Tel: 0086-21-69591111 0086-519-87327575
13817553745 13817069956 13918873922 13918876288
传真 Fax: 0086-21-69595488
邮箱 E-mail: salmaf@jwell.cn sales@jwell.cn
www.jwell.cn www.jwellplate.com



版本号Edition No. : 2018.04

上海金纬片板膜设备制造有限公司
SHANGHAI JWELL PLATE & SHEET EQUIPMENT CO., LTD.
常州金纬片板膜科技有限公司
CHANGZHOU JWELL PLATE & SHEET EQUIPMENT TECHNOLOGY CO., LTD.

上海金纬机械制造有限公司 中国塑料机械工业协会副会长单位

上海金纬公司是挤出类塑料机械设备专业制造商，总部位于上海市西郊，在上海、苏州、常州、广东、舟山有五大生产基地，占地面积超过1000亩。公司拥有员工3000余人，其中技术管理人员400多名。每年生产2000多（台）套高档的塑料挤出生产线，并出口到世界各地。

上海金纬片板膜设备制造有限公司作为中国塑料片板膜机械行业的领先企业，2017年在常州金纬产业园投资成立了常州金纬片板膜科技有限公司。这是一家专注于光学类片板材以及高分子卷材挤出装备的科技公司。

公司下设技术中心、质检中心、市场营销部、综合管理部、4个热处理氮化车间及10个大型金加工车间，拥有近1000台大型精密加工设备和各类先进检测设备。



是中国塑料机械行业的著名品牌。

公司产品已遍布全国各地，并出口到世界各大洲，且已成功进入德国、美国、日本、意大利、西班牙等发达国家市场。

“品质卓越 完美如一”

是金纬公司的质量方针，是全体员工努力的方向。

“诚实待人”

是我们铸就“百年金纬”的核心理念。

董事长：何海潮 电话：+86-21-69596060

Shanghai JWELL Machinery Co.,Ltd. is the largest and most professional plastic extrusion manufacturer in China. Its headoffice locate in the western district of Shanghai. There are 5 production bases, which are located in JiaDing district of Shanghai, ZhouShan City of ZheJiang Province, Taicang City of JiangSu Province, Dong-Guan City of GuangDong Province and LiYang City of JiangSu Province. Totally covering areas over than 7,000,000 square meters. It has more than 3000 staffs, about 400 technical and managing staffs among them. We produce more than 2000 advanced extrusion line every year which were exported to all over country in the world.

As the leading enterprise in plastic sheet machinery industry, Shanghai Jwell Plate & Sheet Equipment Co.,Ltd found Changzhou Jwell Plate & Sheet Equipment Technology Co.,Ltd in Changzhou JWELL industrial park in 2017. It is a company be specializing in manufacturing optic sheet and waterproof sheet extrusion equipments.

We have different department which include technical department, quality control department, marketing department, comprehensive department and 4 heat treated & nitrided processing warehouse, 10 large CNC processing warehouse, which have oven than 1000 large&high quality precise processing equipment.

JWELL and **Jinhailuo** are famous brands in Chinese plastic machinery industry.

JWELL machinery has been sold across the country, and exported to all continents over the world, including the market of developed country, such as Germany,Amercia, Japan, Italy, Spain and so on.

"Excellent Quality, Perfect All" is Jwell' s quality policy, and all staff's working direction.

"Be honest' is the core idea for us to contribute " Century JWELL"

President: He Haichao Email: he@jwell.cn



PC、PMMA光学片材生产线

PC PMMA Optic Sheet Extrusion Line

PC、PMMA光学片材生产线

为了满足市场的需要，上海金纬凭借先进的工艺技术及装备向用户提供了光学级片材生产线。根据原料的流变性设计的专用螺杆和精密的计量泵系统和模具保证了熔体的均匀稳定和片材优异的光学性能；精密的压光系统给片材的机械物理性能提供了保障。

To meet the demands of market, Shanghai JWELL supply customer PC PMMA optical sheet extrusion lines with advanced technology, the screws are specially designed according to the rheological property of raw material, precise melt pump system and T-die, which makes the extrusion melt is even and stable and the sheet has excellent optical performance. Precise calender system guarantees the mechanical & physical properties of sheets.

主要技术参数 Main technical specification

机型 Model	JW100-1300	JW120-1500
制品宽度 Production width	1000mm	1200mm
制品厚度 Production thickness	0.125-1.2mm	0.175-2mm
挤出机规格 Extruder model	JWS100/38	JWS120/38
设计挤出产量 Designed capacity	250Kg/h	450Kg/h

备注：以上规格参数如有变更，恕不另行通知。Note: The specifications are subject to change without prior notice.

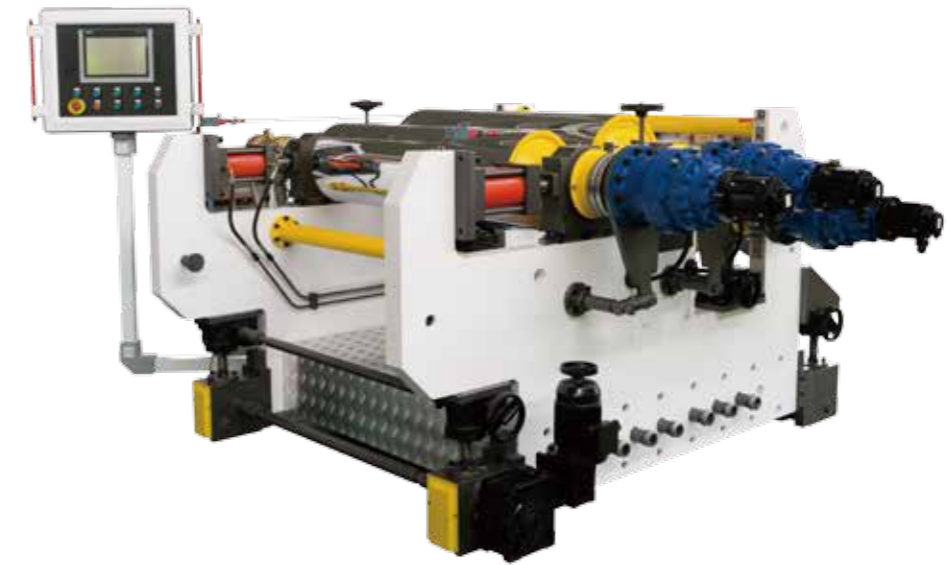

PC、PMMA光学片材

产品主要应用于汽车工业；电子、电器工业的薄膜开关；电脑、手机、商务通的液晶显示屏；太阳镜、太阳帽、镀膜、防护面罩；特种印刷；医药包装等领域。

PC PMMA optic sheet

It is mainly used in automotive industry, film switch of electronics, LCD for computer, mobile, sunglass, helmet, special printing, medicine packing and so on areas.

改性片板材挤出生产线 Modified Plastic Sheet & Plate Extrusion Line

改性片板材挤出生产线

采用积木式同向平行双螺杆挤出机。一步法工艺，减少造粒环节。产品可用于电子、箱包、汽车、建材等领域。
Adopt building block type co-rotating parallel twin screw extruder, which can compound material and produce the sheet by one step without pelletizing production. The sheet can be used in the industry of electronics, bags and suitcase, automobile, building material, and so on.

优点：无需造粒，减少了冷却、切粒、包装以及再加热过程，为工厂节约厂房空间、包装成本和电费，并大大提高了生产效率。
Advantage: no need to pelletizing, reduce some procedure of cooling, granulating, packaging and re-heating. Saving factory space, and reducing the cost of packaging and electricity consumption for manufacturers, meanwhile, increasing the productivity.



主要技术参数 Main technical specification

用途Application	玻纤Glass fiber、钙粉CaCO ₃ 、炭黑Carbon black、增粘Tackify		
机型 Model	JWE65/36-1000	JWE75/40-1200	JWE95/44-2200
制品规格Products width	800mm	1000mm	2000mm
制品厚度Products thickness	0.2-2mm	1-6mm	2-10mm
设计产量Capacity	600kg/hr	800kg/hr	1200kg/hr

备注：以上规格参数如有变更，恕不另行通知。Note: The specifications are subject to change without prior notice.



双螺杆免干燥排气型PET片材生产线 Twin Screw Dyer-free Vented PET Sheet Extrusion Line

上海金纬推出的双螺杆免干燥排气型PET片材生产线具有低能耗、工艺简单，设备使用维护方便的特点。其特有的螺杆组合结构有效的减少了PET树脂的粘度降，对称式薄壁型辊筒提高了冷却效率同时提升了产能和片材品质，多组分喂料装置可合理的控制新料、回料、色母等的比例，所生产的片材可用于吸塑印刷包装等领域。

Shanghai JWELL develops the parallel twin screw extrusion line for PET sheet, this line equipped with degassing system, and no need drying and crystallizing unit. The extrusion line has the properties of low energy consumption, simple production process and easy maintenance. The segmented screw structure can reduce the viscosity loss of PET resin, the symmetrical and thin-wall calender roller heighten the cooling effect and improve the capacity and sheet quality. Multi components dosing feeder can control the percentage of virgin material, recycling material and master batch precisely, the sheet is widely used for thermoforming packaging industry.

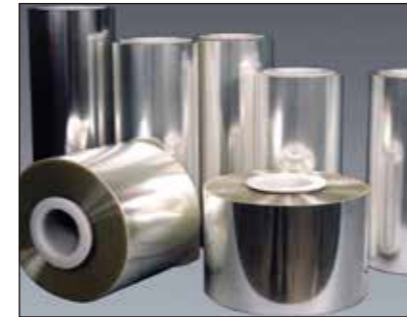

主要技术参数 Main technical parameters

机型 Model	共挤线 Multi layer	单层线 Single layer	高效 Highly-efficient
挤出机规格 Extruder specification	JW75&36/40-1000	JW75/40-1000	JW95&52/44-1500
制品厚度 Thickness of the product	0.15-1.5mm	0.15-1.5mm	0.15-1.5mm
主电机功率 Main motor power	110kw/45kw	110kw	250kw/55kw
最大挤出产量 Max extrusion capacity	500kg/h	450kg/h	800-1000kg/h

备注：以上规格参数如有变更，恕不另行通知。Note: The specifications are subject to change without prior notice.

APET PETG CPET片材生产线

APET, PETG, CPET Sheet Extrusion Line

APET、PETG、CPET单层及多层共挤片材生产线 APET, PETG, CPET single-layer or multi-layer sheet extrusion machine

是目前国内技术先进、工艺成熟、设备稳定的片材生产线之一，与国内同类设备相比，综合效能高30%以上，此生产线同时也可用于生产PS、PP、PE等片材制品。

It's one of the most advanced production lines with matured technology and stability in China. Compared with other same kind equipment, it's over 30% higher in overall efficiency. Line is suitable for PS, PP, PE as well.

主要技术参数 Main technical parameters

机型 Model	共挤线 Multi layer	单层线 Single layer	高效 Highly-efficient
挤出机规格 Extruder specification	JW120/65-1000	JW120-1000	JW120-1500
制品厚度 Thickness of the product	0.20-1.5mm	0.15-1.5mm	0.15-1.5mm
主电机功率 Main motor power	110kw/45kw	110kw	160kw
最大挤出产量 Max extrusion capacity	500kg/h	450kg/h	800kg/h

备注：以上规格参数如有变更，恕不另行通知。Note: The specifications are subject to change without prior notice.

PETG片材 PETG sheet

PETG俗称低温PET，产品具有高光泽、高透明、有优良的阻隔性、自粘性的新型环保包装材料。可用于胶水粘合、高周波加工。PETG is called low temperature PET, it's a new environment-friendly packing material with features such as high luster, good transparency, excellent barrier property, self-adhesion, which is used for glue bonding and high-frequency processing.

CPET片材 CPET sheet

CPET是一种改性PET，具有耐高温的特性，通常用于微波炉烤盘等。

CPET is a kind of modified PET. With good resistance to high temperature, it is usually used for package in microwave oven.

PET立体光栅片 PET stereoscopic optical grating sheet

广泛适用于化妆品、药品、烟酒包装及一般商品等三维防伪外包装以及文具、挂件、宣传广告、海报、各式卡片、吊卡等领域。It can be used as top grade package for cosmetics, medicine, tobacco & alcohol and common goods such as stationery, advertisements, posters and all kinds of cards.

PLA片材 PLA sheet

聚乳酸PLA是可降解树脂，可用于水果、蔬菜、鸡蛋、熟食和烘烤食品的硬包装，也可用于三明治、饼干和鲜花等商品的包装。

PLA is a kind of line shape Aliphatic Polyesters. PLA can be used in rigid package of fruits, vegetables, eggs, cooked food and roast food, also can be used for packaging of sandwich, biscuit and some other packages like fresh flower.

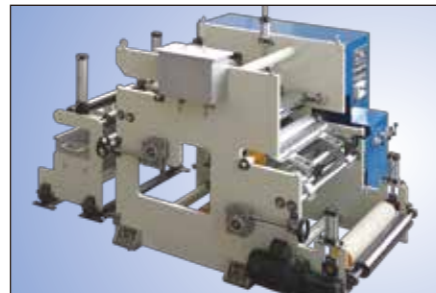

TPO PVC EVA PE防水卷材生产线

TPO, PVC, EVA, PE Waterproof Sheet Extrusion Line

TPO防水卷材生产线 TPO Waterproof sheet Extrusion Line

金纬公司新技术采用实心轧辊复合工艺，使国内卷材的抗风揭性能达到进口产品标准。TPO防水卷材，是由热塑性聚烯烃加入抗氧化剂、防老剂、软化剂等挤出成型的，中间有聚酯网布增强层，表面附以织物纤维、铝膜而制成的新型防水卷材。TPO防水卷材具有优异的耐候性和柔韧度。主要各种屋面、地下室、隧道等建筑用防水领域。

Jwell company adopts the solid roll for combining multilayers, this new technology make the TPO sheet having a good function against wind uncovering. TPO waterproof sheet is a new type of waterproof product, which is produced with thermoplastic polyolefin plus antioxidant and plastifier and so on, the middle layer is polyester fabric for reinforcement, the surface is laminated with textile fiber and aluminum foil. This kind of TPO waterproof sheet has the features of good weatherproof and suppleness. It is mainly used for house, tunnel, basement architecture and other waterproof fields.

PVC、EVA、PE 防水卷材生产线 PVC, EVA, PE waterproof sheet Extrusion Line

主要用于PVC、EVA、PE等防水卷材，产品工业与建筑业的各种屋面防水，地下室，水库，堤坝，公路隧道，铁路隧道，防空洞，粮库，垃圾厂，废水处理等建筑防水工程。

Mainly used for producing PVC, EVA, PE Waterproof Sheet, it is used for house waterproof industry, architecture, and basement, architecture waterproof project in reservoir, dam, road tunnel, rail way tunnel, bomb shelter, grain depot, refuse dump, waste water disposal, etc.



主要技术参数 Main technical specification

机型 Model	JWP130/26+JWP130/26-2400	JWE75/36+JWE65/36-3400
产品结构 Product structure	PVC+增强层 (Net) +PVC	TPO+增强层 (Net) +TPO
制品宽度 Products width	2200mm	3200mm
制品厚度 Products thickness	0.5-3mm	0.8-3mm
挤出机规格 Extruder model	JWP130/26	JWE75/36, JWE65/36
设计挤出产量 Designed capacity	1500Kg/h	1200Kg/h

备注：以上规格参数如有变更，恕不另行通知。Note: The specifications are subject to change without prior notice.



8米土工膜/防水卷材生产线

8m Geomembrane/Waterproof Sheet Extrusion Line

超宽幅土工膜/防水卷材生产线

根据防水和土工领域的特殊要求，上海金纬推出了低剪切的高产低耗挤出系统，以及专用辊架和辊筒结构设计。提高了超宽幅土工膜产品的性能和厚度精度。

Extra-width Geomembrane/Waterproof Sheet Extrusion Line

Referring to the special request of waterproof and geomembrane industry, Shanghai JWELL launched a high capacity extrusion line with low shear & energy consumption. The exclusive design of calender frame and roller structure are helpful to highten the performance of extra-width geomembrane and precision of thickness.

主要技术参数 Main technical specification

机型	JW150-4000(无纺布-PE-无纺布)	JW200-8000(无纺布-PE-无纺布)
Model	JW150-4000 non-woven fabric-PE-non-woven fabric	JW200-8000(non-woven fabric-PE-non-woven fabric)
制品宽度 Products width	4000mm	8000mm
制品厚度 products thickness	0.8-3mm	1-3mm
挤出机规格 Extruder model	JWS150/33	JWS200/33
设计挤出产量 Capacity	700Kg/h	1200kg/h

备注：以上规格参数如有变更，恕不另行通知。Note:The specifications are subject to change without prior notice.



PE土工膜/防水卷材

主要用于民用建筑防水：包括种植屋面、平屋面、坡屋面、建筑物地下防水；以及工业工程防水：包括水库、堤坝、水池防水、隧道、粮库、人防工程、垃圾掩埋场、人工湖防水等。

PE Geomembrane/Waterproof Sheet

It is for waterproofing usage in industrial & civil buildings including the green roof, flat roof and the sloping roof. Underground waterproof: reservoir, dam, pool, waterproof usage in Tunnel, grain depot, artificial engineering, landfill, Artificial lake.



PVC地板革/装饰片材/仿大理石板挤出生产线 PVC Floor Leather/Decoration Sheet/Lamination Marble Board Extrusion Line

PVC地板革具有耐磨、耐腐、防滑、防渗、阻燃的性能,广泛用于机车、宾馆、酒店、娱乐厅、展馆、家庭。可以根据客户的要求,配置不同的设备组件,用于生产单层、多层复合产品;也可增加放卷装置,生产内增强产品或表面复合无纺布、PVC装饰膜等的产品。

PVC Floor leather has the performance of anti-friction, corrosion resistance, skidproof, impermeable and inflaming retarding, and is widely used on auto, hotel, amusement place, exhibition hall, house, etc. The structure of this production line is simple, and convenient to operation. According to customers' requirement, equipped with different components, used for producing single layer, multi-layer composite production and also can be equipped with unreeling unit, used for producing inner strengthen production or surface compound non-woven fabrics and PVC decoration film, etc.

PVC装饰片材特点: 一般可以分为两大类,透明和非透明材料,是室内外广告的载体。可以用单台或多台挤出机进行单层或多层共挤出成型。

Character of PVC decoration sheet: decoration sheet can be divided into two kinds: transparent and non-transparent material. Single layer or multi layer sheet could be produced.

UV仿大理石板

板材表面覆仿大理石纹薄膜,或者热转印仿大理石纹并UV固化处理,良好的抗划伤性,耐刮擦性;板材花色、品种多样,施工方便;在室内墙体装潢中替代大理石等天然石材,良好的耐老化、抗紫外线、耐黄变,绿色环保、无辐射。

UV Imitation Marble Bboard

Board surface coat imitation marble film, or laminate imitation marble and through curing treatment, good anti scratch, anti scratch resistance; Board with variety of color, it's convenient to construct; Instead of marble etc. natural stone in the interior.



主要技术参数 Main technical specification

型号 Type	双层 Double layers	三层 Three layers
制品宽度 Products width	1500-2000mm	2000-3000mm
挤出机规格 Extruder specification	SJZ65/132 - SJZ80/156	SJZ65/132 - SJZ80/156 - SJZ65/132
最大挤出量 Max output capacity	500-550kg/h	600-750kg/h
主电机功率 Main motor power	37kw/55kw	37kw/55kw/37kw

备注: 以上规格参数如有变更, 恕不另行通知。 Note: The specifications are subject to change without prior notice.



PVC透明软/硬片生产线

PVC Transparent Soft and Rigid Sheet Extrusion Line

PVC挤出透明硬片生产线

PVC挤出透明片材具有阻燃自熄、优质价廉、透明度高、表面光泽好、晶点少、水纹小、耐冲击性强且易于成型等特点，广泛应用于各类工具、玩具、电子、食品、医药、服装等行业的吸塑、折盒、包装等。

PVC transparent rigid sheet extrusion line

PVC transparent sheet have many advantages of fire-resistance, high quality, low cost, high transparent, good surface, no spot, less water wave, high strike resistance, easy to mould and etc. it applies to different kinds of packing ,vacuuming and case, such as tools, toys, electics, food, medicine and clothes.

PVC挤出透明软片生产线

PVC透明软板软门帘是传统棉门帘的换代产品。本产品具有柔软、透明、绝缘、安全、绿色、环保、耐酸碱、无异味、易清洗等特点，能够保冷、保温、节能、防尘、防风、保湿、防腐、防火、防静电、防强光、防紫外线、隔音、桌垫、采光、工业减振、安全警示、铺地面墙面、器物表面防护和漆膜保护，可用于冷冻、食品、印刷、纺织、电子、仪表、制药、仓储、商场等场所。对带电作业场所的绝缘，有害弧光的遮断，均起到很好的效果。

PVC transparent soft sheet extrusion line

PVC transparent soft sheet is product insteading of the traditional door curtain. It is soft, clear, insulation, safe, environmental protection, acid resistance, no peculiar smell, easy to clean, and etc, also can be used in cold and heat insulation, save energy,wind-proof, keep humidity, anti-corruption, fire proof, anti static. ultraviolet radiation proof, sound proof, table pad, daylighting,industrial damping, safety warning ,protect surface, these application used in refrigeration, foodstuff, printing, weaving, electrics,instrument, medicine, storage. It has good effect on insulation for electricity, and harmful light.



主要技术参数 Main technical specification

机型 Modle	SJP120/21-1500	SJZ80/156-1500
制品宽度 Product width	1220mm	1220mm
制品厚度 Product thickness	0.3-1.5mm	0.3-3mm
挤出机规格 Extruder spetication	SJP120/21	SJZ80/156
主电机功率 Main motor power	90KW	75KW
设计挤出产量 Designed extrusion output	350KG/H	300KG/H

备注：以上规格参数如有变更，恕不另行通知。Note:The specifications are subject to change without prior notice.



PMMA、GPPS、APET(PETG)板材生产线 PMMA,GPPS, APET(PETG) Plate Extrusion Line

PMMA板材(亚克力板/GPPS板) PMMA board (Acrylic board/GPPS board)

产品分类：普通PMMA板材主要用于广告、装饰、装潢、工艺制品、标本标牌等；电镀板用于真空电镀塑料镜片；照明类导光板用于超薄灯箱、LED平板显示灯和海报架等广告装饰方面；液晶类导光板用于电脑、电视等液晶显示组件。金纬提供的板材挤出生产线可用于加工PMMA或PC扩散板。

Application of product: common PMMA plate is mainly used in the field of advertisement, decoration, art ware, escutcheon and specimen etc; the electroplated plate is used for plastic mirror; Light panel is used for ultra light box, flat panel display lamp of LED, poster stand and advertising decoration etc. LCD panel can be used for the display of computer and television. JWELL'S plate extrusion line is suitable for producing the PMMA or PC diffusion plate.



PET厚板材生产线 PET thick plate extrusion line

适用于生产PET厚板材。采用普通APET原料及特殊改性PET原料加工，由于其性价比比PC更优越，在许多领域逐渐代替PC耐力板，用于建筑、装饰、广告等。

PET thick plate is made from the normal APET material and special modified PET material, due to its lower cost when compared with the PC, it can gradually substitute PC plate in many fields, and it can be used in construction, decoration and advertisement and etc.

主要技术参数 Main Technical Parameters

机型 Model	JW-150/90-2700	JW120/45-1500	JW120-1500	JW130-2300
适用原料 Suitable material	PMMA、GPPS	PMMA、GPPS	APET	改性板材级PET
制品宽度 Products width	2500mm	1300mm	1220mm	2100mm
制品厚度 Products thickness	2-15mm	1-10mm	1-3mm	1.5-6mm
挤出机规格 Extruder model	JWS150/38; 90/35	JWS120/38; 45/30	JWS120/38	JWS130/38
最大挤出产量 Max extrusion capacity	700Kg/h	450Kg/h	400Kg/h	500Kg/h

备注：以上规格参数如有变更，恕不另行通知。Note:The specifications are subject to change without prior notice.



PC耐力板生产线、PC波浪板生产线

PC Sheet Extrusion Line、PC Corrugated Sheet Extrusion Line

PC耐力板 适用范围：园林、游艺场所奇异装饰及休息场所的廊亭；商业建筑的内外装饰品，现代城市楼房的幕墙；航空透明集装箱、摩托车前风挡、飞机、火车、轮船、汽车、汽船、潜艇及玻璃军警盾牌；电话亭、广告路牌、灯箱广告展示展览的布置；高速公路及城市高架路隔音屏障。

Applicable Scope Of PC Endurance Board: Garden, the recreation place, decoration and the corridor pavilion; Internal and external ornaments in the commercial building, curtain wall of the modern urban building; transparent container of aviation, the windscreen before the motorcycle, the plane, the train, the steamer, the submarine, army and police' s shield, the telephone booth, advertising signpost, the advertisement of the lamp houses, the expressway and overhead way of the city partition protective screen.

PC波浪板： PC波浪板以其优良的耐候性、抗冲击性、及高透光性等优良性能，广泛应用于仓库屋顶和简易建筑构造物的顶棚，如：运动馆、游泳池、滑雪场等内场通道、车站休息亭等等，具有广阔的市场前景。

PC corrugated sheet: PC corrugated board has the merits of good weather resisting property, impact resistance, high light transmission.It is widely used in the roof for warehouses and easy constructions,such as stamming pools,skiing fields,station rest pavilions and so on.

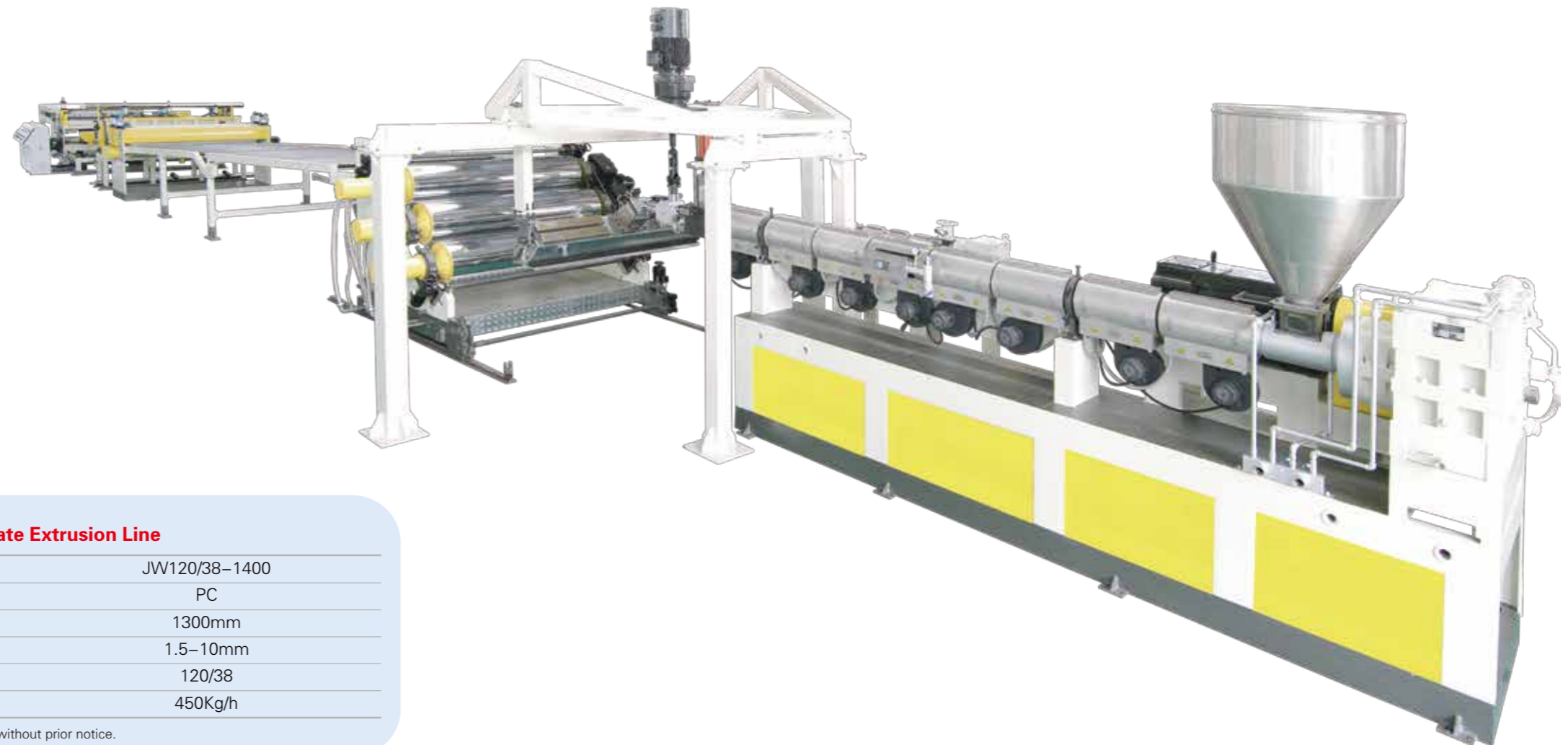
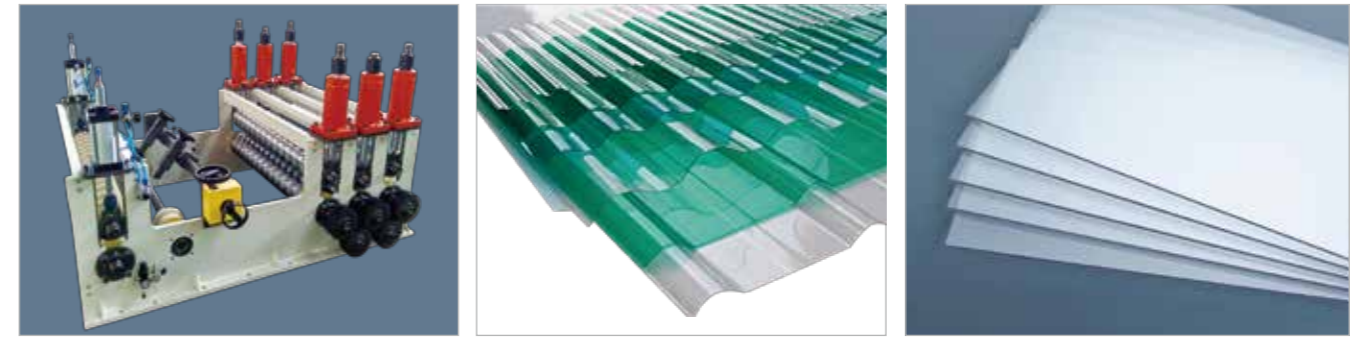

PC板材机组主要技术参数 Main Technical Parameters Of PC Plate Extrusion Line

型号 Model	JW-130/38-2200	JW120/38-1400
适用原料 Material	PC	PC
制品宽度 Products Width	2100mm	1300mm
制品厚度 Products Thickness	2-10mm	1.5-10mm
挤出机规格 Extruder Specification	130/38; 45/30	120/38
最大挤出产量 Capacity (Max.)	550Kg/h	450Kg/h

备注：以上规格参数如有变更，恕不另行通知。Note:The specifications are subject to change without prior notice.

PP/PS片材生产线

PP/PS Sheet Extrusion Line

PP/PS片材生产线

PP/PS片材生产线是上海金纬提供的众多设备中属于较简单且标准的机器，该生产线具有产量高、塑化好，操作方便且设备运行稳定的优点。

PP/PS Sheet Extrusion Line

PP/PS sheet extrusion line is one kind of simple and standard machine among the sheet lines provided by Shanghai JWELL, this line has the advantages of high capacity, good plasticization, easy operation and stable running.

主要技术参数 Main technical parameters

机型 Model	JW150/120/90-1800	JW150/60-1200	JW130/60-1000	JW120-1000	JW100-800
片材宽度 Width	1500mm	1000mm	900mm	800mm	600mm
片材厚度 Thickness	0.3-2mm	0.3-2mm	0.3-2mm	0.2-2mm	0.1-0.8mm
生产能力 Capacity	800-1000kg/h	800kg/h	550-600kg/h	350-400kg/h	200-250kg/h
设计线速度 Designed line speed	60m/min	40m/min	30m/min	25m/min	20m/min
辊筒直径 Calendar diameter	Ø900mm	Ø700mm	Ø600mm	Ø500mm	Ø400mm

备注：以上规格参数如有变更，恕不另行通知。Note:The specifications are subject to change without prior notice.



PP/PS吸塑片材、PP文具片 PP/PS thermoforming sheet、PP stationery sheet

PP/PS单层片材、PP/PS共挤双色片材，PP双面高透明片材等用于吸塑包装行业的片材。PP透明片材、磨砂片材（粗砂、细砂）、双色片材等用于文具包装行业的片材。

PP/PS single-layer, co-extrusion two-color, double-side transparent sheets are used in thermoforming and packing industry. PP transparent sheet, dull polish sheet (coarse and fine), two-color sheet and some other sheets are used in stationery industry.

PP发泡片材 PP foaming sheet

PP发泡片材主要文具领域的文件夹等，包装领域的隔物板等，以及汽车内饰领域的遮光板、隔音板、行李架、内装饰件、盖子、箱体等。

PP foaming sheet is mainly used for folder of stationery industry and separation plate of packaging field, also is used for producing visor, acoustic panel, luggage rack, interior decoration parts, cover, and box etc. in car interior decoration industry.

PS导电片 PS electricity conductive sheet:

主要应用于半导体电子电脑通讯等产品，特别应用于要求无尘、无静电、放电防护及遮蔽电磁波/无线电频率干扰之配件或设备的包装。

Mainly used for packing of semi-conductive electric components, computer products which require no dust, not static electricity, no radio frequency or facilities.

PP聚丙烯石粉环保片材生产线 PP and Calcium Powder Environmental Protection Sheet Extrusion Line

PP+ 石粉环保片材生产线:

金纬机械研制开发的PP+石粉环保片材生产线，采用三台挤出机三层或四层共挤法，选用金纬新设计的PP+石粉专用排气式螺杆结构，PLC电脑控制和自动测厚仪跟踪检测，从而有效利用石粉比例，在降低片材原料成本的基础上，又确保片材的综合物理性能和后续可加工性能，使生产线产能指数达到良好状态，是目前国内先进的片材机组之一。

PP+CaCo3 environmentally-friendly sheet extrusion line

It developed by Jwell company uses the three extruders for 3 or 4 layers co-extrusion. This line adopts the Jwell latest designed PP+CaCo3 vented screw and the PLC computer controlling device and automatic thickness detection device so that the machine can maximize the percentage of the CaCo3 in the sheet production to reduce the cost of the sheet and the sheet produced can gain the good physical properties and further processing abilities. It is the most advanced sheet machine in China.

主要技术参数 Main technical specification

机型 Model	JW-120/100/45-1500
分层形式 Layer structure	A/B/C/A
制品宽度 Products width	1320mm
制品厚度 Products thickness	0.3-1mm
最大挤出产量 Designed capacity	800Kg/h

备注：以上规格参数如有变更，恕不另行通知。Note:The specifications are subject to change without prior notice.



PP木粉/竹粉/麻纤维板材生产线 PP and Wood Powder, Bamboo Powder and Fiber Composite Sheet Extrusion Line

PP+ 木粉板材/PP+ 麻纤维板材生产线: PP+ 木粉、PP+ 麻纤维复合片材生产线，采用锥形双螺杆挤出机挤出，配以特殊工艺手段，是金纬推出的又一个国内领先的生产线机组。此复合片材具有深成型、深拉伸，与各种面料一次热压成型复合的制品，边角余料可回收利用等特点，被广泛应用于高档汽车内饰件、顶棚、后搁物板、行李箱基材及宾馆、餐厅、娱乐场所的装潢。

PP+ fiber sheet/PP+ wood powder sheet extrusion line: This production line adopts conical twin-screw extruder, with specially processing method, which is another most advanced technology in China. This product features of well-shaped, easily processed, recycling and reuse of the off cutting once-complexion with other material of sheet by hot pressing. It can be widely applied in the decoration of automobile ornaments, ceiling, booth, suitcase, hotel, restaurant, entertainment area and etc.

主要技术参数 Main technical specification

机型 Model	SJZ92/188	SJP140/25
制品厚度 Products thickness	1-6mm	2-8mm
制品宽度 Products width	1200-1600mm	1500-2000mm
最大挤出量 Max output capacity	350-450kg/h	500-600kg/h
主电机功率 Main motor power	110kw	160kw

备注：以上规格参数如有变更，恕不另行通知。Note:The specifications are subject to change without prior notice.



PP、EVA、EVOH、PS、PE多层共挤阻隔片材生产线 PP, EVA, EVOH, PS and PE Multi-Layer Sheet Co-Extrusion Line

PP、EVA、EVOH、PS、PE多层共挤阻隔片材生产线

由于市场对产品越来越苛刻的要求，上海金纬开发了先进的五层对称和七层非对称分配技术，使该设备生产出的产品获得了更优异的阻隔性能。

PP, EVA, EVOH, PS And PE Multi-layer Sheet Co-extrusion Line

To meet market's high request on products, Shanghai JWELL develops advanced technology of five layer symmetrical distribution and seven layer asymmetrical distribution, which makes the sheets having better barrier performance.

PP/EVA/EVOH/EVA/PP五层或七层共挤复合高阻隔保鲜包装片材

是具有良好的阻气性、阻湿性，是气体阻隔性能良好的一种塑料包装材料。主要应用于果冻包装，高档肉食品、快餐米饭等食品包装，药品、化妆品等包装。

PP/EVA/EVOH/EVA/PP five or seven multi-layer co-extrusion high barrier fresh keeping sheet

has the excellent anti-oxygen and anti-humidity features. It is one of the best barrier packing materials. Mainly used for Jelly packing, meat packing, snack food packing, medicine and cosmetic packing and so on.

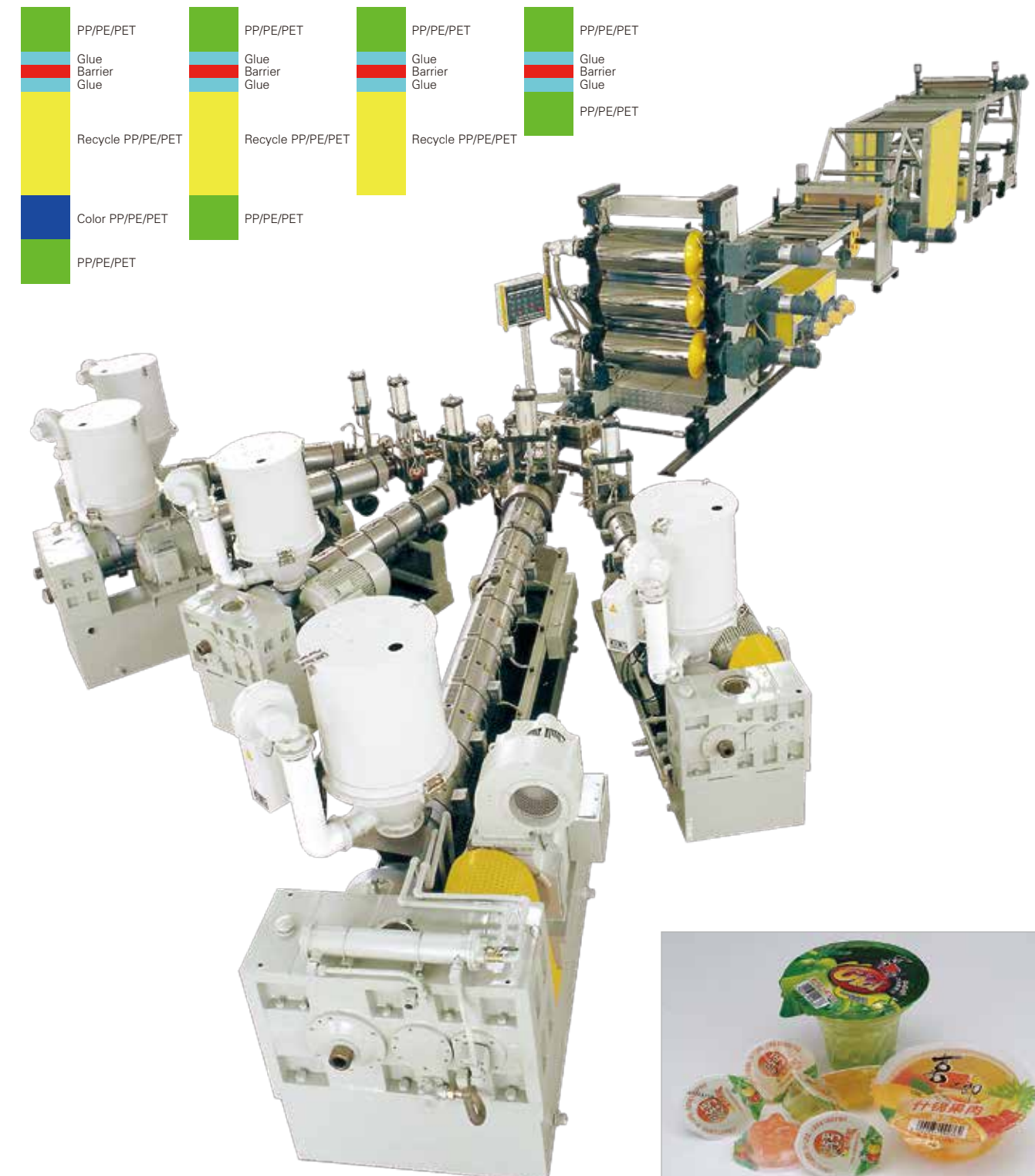

主要技术参数 Main Technical Parameters

机型 Model	JW100/45/45-1000	JW120/45/30/65-1200	JW150/45/45-1500
适用原料 Suitable material	PP、PE、PET、PS		
片材宽度 Width	800mm	1000mm	1200mm
片材厚度 Thickness	0.5-2mm	0.5-2mm	0.5-2mm
生产能力 Capacity	300kg/h	400kg/h	650kg/h
设计线速度 Designed line speed	15m/min	20m/min	30m/min
辊筒直径 Calendar diameter	Ø400mm	Ø500mm	Ø600mm

备注：以上规格参数如有变更，恕不另行通知。Note: The specifications are subject to change without prior notice.

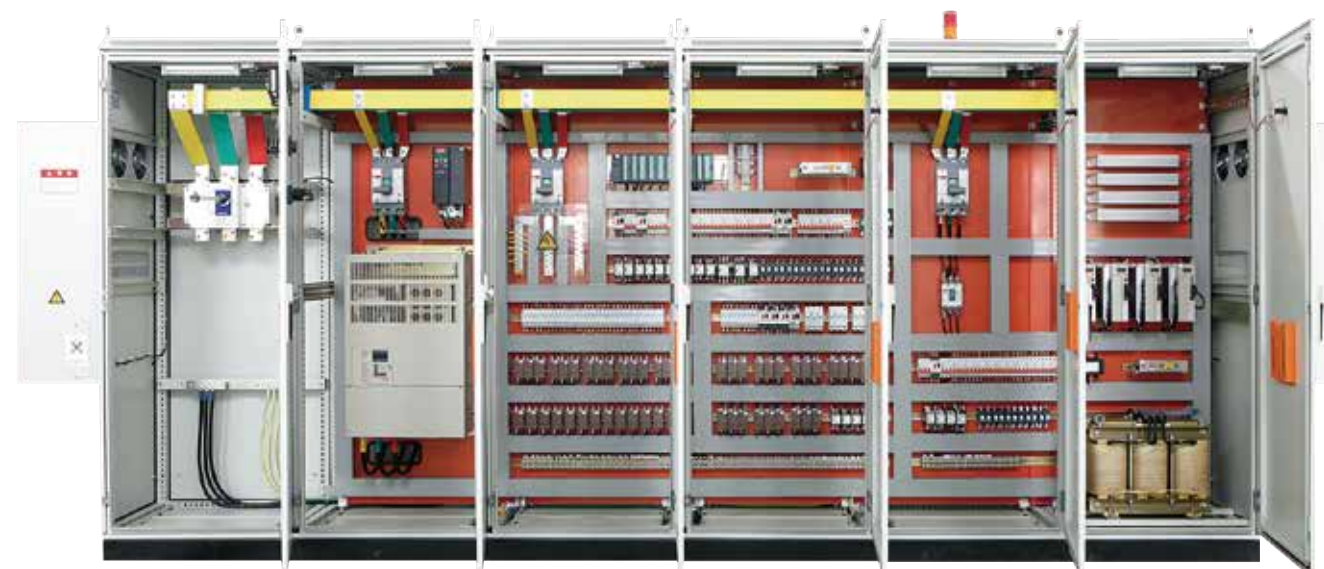

ABS、HIPS、PMMA冰箱板、洁具板生产线 ABS, HIPS, PMMA Refrigerator Plate, Sanitaryware Plate Extrusion Line

ABS、HIPS、PMMA冰箱板、洁具板生产线

上海金纬提供国内领先的大产量低能耗板材挤出生产线，具备集中供料系统及机械手自动堆垛装置，实现了高程度的自动化生产功能，大大的降低生产成本并提高了产品品质。该生产线深受广大客户的欢迎。

ABS, HIPS, PMMA Refrigerator Plate, Sanitaryware Plate Extrusion Line

Shanghai JWELL provides the leading plate extrusion lines with large output and low energy consumption, the lines are equipped with concentrated material feeding system and automatic piler, its automatic production function reduce the cost of processing and improve product quality highly. This extrusion line is popular in our customers.

冰箱板 Refrigerator board

主要用于冰箱冰柜门胆、内胆、抽屉、接水盘、饮水机等。

It has wide application in production of refrigerator door and inner gallbladder, drawers, water dispensers, etc.

洁具板 Sanitaryware plate

用于卫浴产品如：浴缸、淋浴房、蒸汽房、洗脸槽。

It is widely applied in the field of bath products, such as the bathtub, the shower cabinet, the vapor room, washing bowl, etc.

广告板 Advertising board

主要应用于：指示导向牌、胸标牌、机械标牌、广告装潢、室内装饰等。

This board is mainly used in guiding board, machinery sign, advertisement decoration, indoor decoration and so on.

箱包板 Baggage plate

主要用于各种拉杆箱、行李箱、休闲包等箱包。

It is mainly applied in field of draw-bar boxes, luggage cases, recreation bags, etc.

汽车板 Car plate

主要用途：汽车车顶、仪表板；座椅靠板、车门板、窗框；摩托车、沙滩车、代步车、高尔夫球车等外壳。

It is mainly used for producing tops of cars and buses, instrument boards, backrest, car doors, window frames, shells of the motorcycles, golf vehicles, etc.

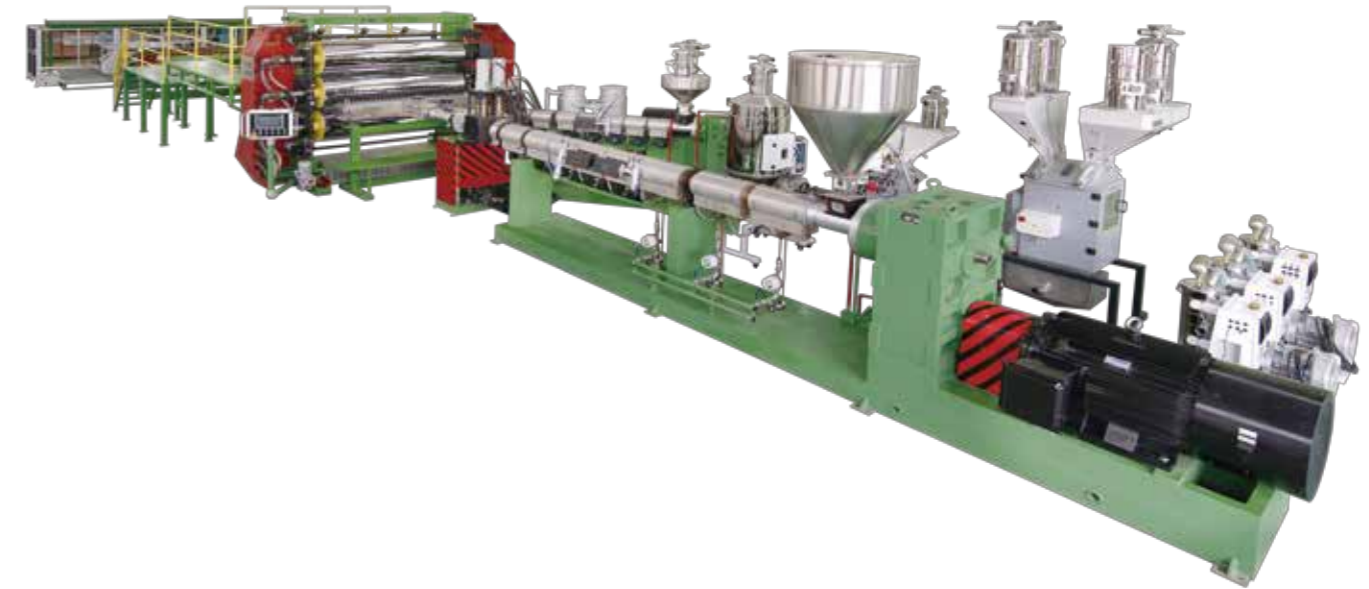

主要技术参数 Main technical specification

机型 Model	JW160/60-2200	JW130/60-2000	JW120/60/45-1900	JW130/70/60-2700
适用原料 Suitable material	ABS、HIPS	ABS、HIPS	ABS、HIPS	ABS、PMMA
挤出机规格 Extruder model	JWS160/38,60/35	JWS130/38、60/35	JWS120/38,60/35,45/35	JWS130/38,70/35,60/35
共挤分层形式 Feed form	A/B,A/B/A	A/B,A/B/A	A/B/C	A/B/C/B/A
制品宽度 Products width	2000mm	1800mm	1700mm	2100-2500mm
制品厚度 Products thickness	1-6mm	1-6mm	1-6mm	2-8mm
最大挤出产量 Designed capacity	1500Kg/h	1200kg/h	550Kg/h	700Kg/h

备注：以上规格参数如有变更，恕不另行通知。Note:The specifications are subject to change without prior notice.

PC、PP、PE中空格子板生产线

PC, PP, PE Plastic Hollow Cross Section Plate Extrusion Line

PC阳光板

主要应用于办公楼、大厅、商场、体育场馆、公用设施的采光顶，车站、停车场、凉亭、休息厅走廊的雨棚，高速公路及城市高架路隔音屏障等。

PC hollow sheets

are mainly used in the skylight of office building, lobby, marketplace, stadium and public utility etc, and rainshed of station, park, pavilion, lounge and corridor, including the noise barrier of highway and overhead road in city.

PP、PE格子板主要应用于电子、家电、箱包、机械、邮政、食品、医药、农药以及广告装潢等领域用作缓冲保护的包装箱等。

PP PE hollow sheets are used for producing containers and packaging cases for cushioning protection in the industry of electron, household appliance, bags and suitcases, machinery, postal service, food, medicine, pesticides, advertisement and decoration etc.

PP中空建筑模板是一种新型环保的塑料建材，可反复回收利用，主要用于替代钢模板和竹木胶板。

PP hollow building template is one kind of new environmental protection plastic building materials. It can be repeated recycled, and mainly used for replacing the application of steel templates and bamboo & wooden templates.

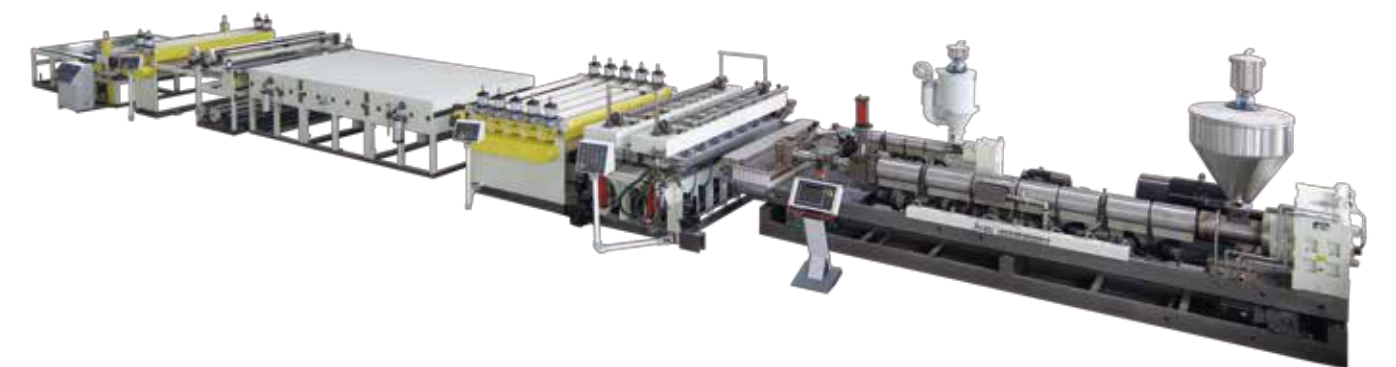
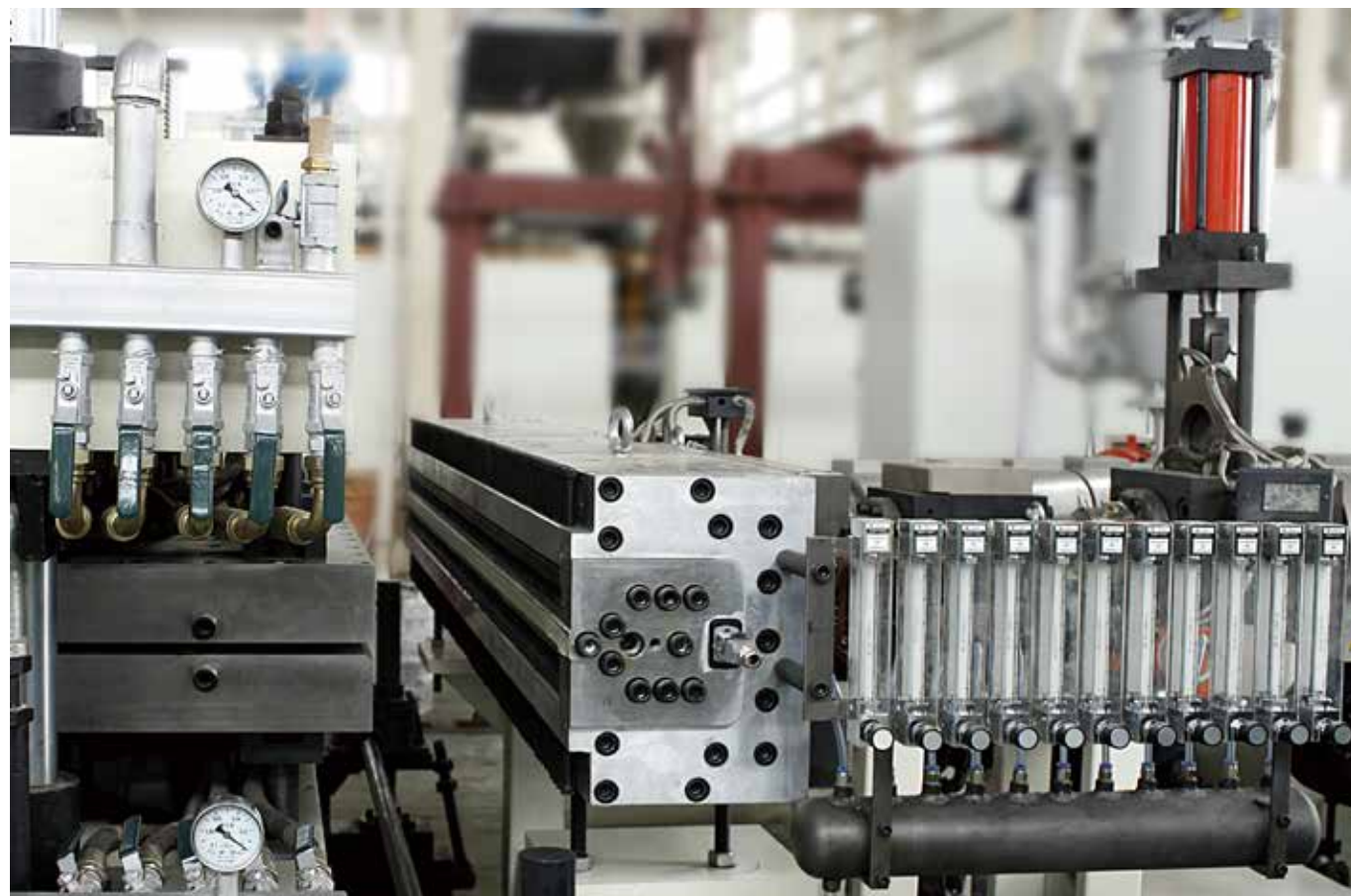
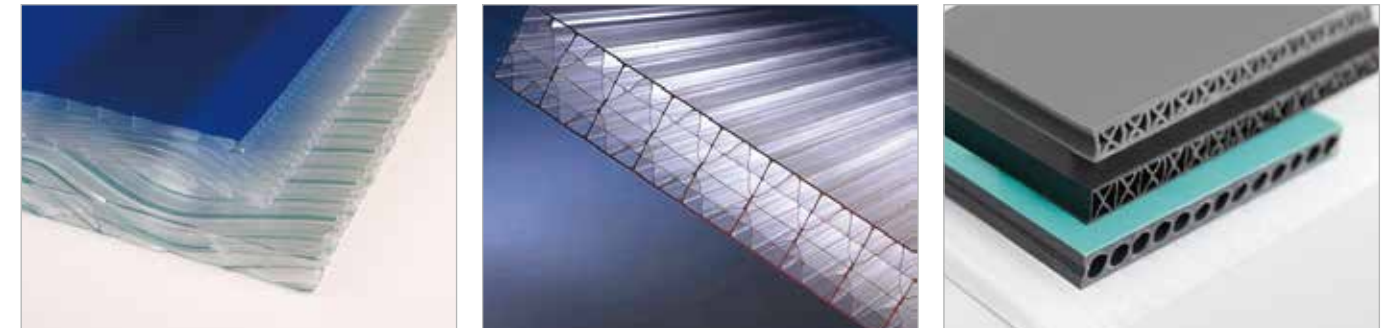

主要技术参数 Main technical specification

机型 Model	JW120/38、JW45/30	JW100/38、JW45/30	JW120/30	JW100/33
适用原料 Suitable material	PC	PC	PP、PE	PP、PE
制品宽度 Products width	2100mm	1300mm	2100mm	1300mm
制品厚度 Products thickness	2-40mm	2-10mm	2-8mm	1.5-8mm
主电机功率 Main motor power	185kw/22kw	132kw/22kw	132kw	110kw
最大挤出产量 Designed capacity	450kg/h	300kg/h	350kg/h	200kg/h

备注：以上规格参数如有变更，恕不另行通知。Note: The specifications are subject to change without prior notice.

PP、PE、ABS、PVC、PVDF厚板生产线

PP, PE, ABS, PVC, PVDF Thick Plate Extrusion Line

PP厚板生产线 PP thick plate extrusion line

PP厚板，可广泛用于化学工业、食品行业、防腐行业、净化行业、环保设备生产行业。2000mm宽PP厚板生产线是金纬新开发的领先于同行的稳定的生产线。

PP thick plate, It is an environment-friendly product and is widely applied in chemistry industry, food industry, anti-erosion industry, environmentally-friendly equipments industry, etc. PP thick plate extrusion line of 2000mm width is a newly developed line which is the most advanced and stable line compared with other competitors.

PE厚板生产线 PE thick plate extrusion line

聚乙烯板材广泛应用于化工、电力等工业上。HDPE板还可作为工程塑料应用在机械、化工等设备上，广泛用于制造冰球场墙板。PE plate is widely applied in chemical and electric power industries. HDPE plate, known as engineering plastics, is used in mechanical and chemical equipments as well as ice hockey ring walls.

PVC厚板生产线 PVC thick plate extrusion line

硬质PVC厚板广泛用于化工、石油、电镀、水净化处理设备、环保设备、矿山、医药电子、通讯、防腐蚀容器、设备电气的护罩，灯箱，广告装潢等行业。

Rigid PVC thick plate is widely used in chemical industry, petrol, electroplating, water purifying equipments, environment-friendly equipments, lamp house and advertisements, etc.

PVDF板材生产线 PVDF plate extrusion line

PVDF板材是用聚偏氟乙烯树脂经过高温挤出成型的纯净板材，挤出过程不含添加剂（如紫外稳定剂、热稳定剂、软化剂、润滑剂或阻燃剂等添加剂）。广泛用于石化、电力、冶金、造纸、纺织、制药和原子能工业等诸多工业领域，特别适用于纯水系统和半导体行业中纯净化学试剂的传输。

PVDF plate is a pure plate extruded with Polyvinylidene fluoride resin, there is no any additive (such as UV stabilizer, heat stabilizer, plasticizer, lubricant or flame retardant etc.). The plate was widely used in petrification, electricity, metallurgy, paper making, spinning, medicine and atomic energy industry and other industries, especially, for the application of conveying the pure chemical agent used in cleaning water system and semiconductor industry.



主要技术参数 Main technical specification

机型 Model	JW120-1600	JW150-2100	JW170-2600	SJZ80/156-1500
适用原料 Suitable material	PP、PE、ABS、PVDF	PP、PE、ABS	PP、PE、ABS	PVC
制品宽度 Products width	1220mm	1500mm	2000mm	1220mm
制品厚度 Products thickness	3-30mm	3-30mm	3-30mm	3-30mm
设计挤出产量 Designed capacity	350Kg/h	500Kg/h	700kg/h	400 Kg/h

备注：以上规格参数如有变更，恕不另行通知。Note: The specifications are subject to change without prior notice.



熔体直接压出生产线 Melted Plastic Material Direct Calendering Production Line

熔体直接压出生产线 Melted plastic material direct calendering production line

本项目是上海金纬针对聚合树脂的石化工厂提供的产品线延伸工程，可解决树脂产能过剩并提高产品附加值。
This project is specially designed for petrochemical plant, it can process the melted resin into sheet (film & plate) directly, which can solve the excess production capacity of petrochemical plant and increase the additional value of product.

原理：石油单体——熔融树脂——最终产品（薄膜、片材、板材）

Procedure: petroleum petroleum——molten resin——final product(film, sheet, plate)

设备流程：反应釜 真空管道 过滤系统 计量泵装置 模具 三辊辅机

machine procedure:reaction still--vacuum adaptors --filtering system--melt pump--T--die--three--roller calender production line



主要技术参数 Main technical specification

机型Model	薄膜流延 Film casting	片材压光 Sheet calendar	板材挤出 Plate extrusion
材料Material	CPP CPE	PET PP HIPS	PMMA PC GPPS PET PE
制品规格Products width	1000-3000mm	1000-2000mm	1000-2000mm
制品厚度Products thickness	0.018-0.25mm	0.2-2mm	1-10mm
设计产量Capacity	1000kg/hr	2000kg/hr	3000kg/hr

备注：以上规格参数如有变更，恕不另行通知。Note:The specifications are subject to change without prior notice.

EVA太阳能封装膜生产线 EVA Solar Film Extrusion Line

EVA太阳能封装膜生产线 EVA solar film extrusion line:

全自动的称重式计量装置，保证多种固体、液体添加助剂及原料高精度喂料；低温挤出系统在保证充分混炼塑化的情况下，防止助剂提前固化交联；流延部分的特殊设计，完美的解决了粘辊、剥离问题；独特的在线回火去应力装置；生产线中多处张力控制系统，使富有弹性的片材在冷却、牵引及收卷过程中平稳输送；在线自动测厚和瑕疵检测装置提供了封装膜制品品质的实时反馈。

Automatic gravimetric feeding system makes sure variety of solid, liquid additives and raw materials high-precision feeding. Low-temperature extrusion systems to ensure adequate mixing in the premise of plastination to prevent crosslinking additives. Special design of Casting part give the perfect solution to roller adhibition and water spalling. Special online tempering device to get rid of inner stress. Tension control system ensure the flexible sheets conveying placidly during cooling, pulling and winding process. The on-line thickness measuring and defect inspecting system can provide real-time feedback of the production quality of EVA solar film.

主要技术参数 Main technical parameters

型号 Model	JW130-1200	JW150-2400
适用原料 Suitable material	EVA	EVA
制品宽度 Products width	810mm	2200mm
制品厚度 Products thickness	0.2-0.8mm	0.2-0.8mm
设计线速度 Designed line speed	10m/min	10m/min
挤出产量 Extrusion capacity	250kg/h	400kg/h

备注：以上规格参数如有变更，恕不另行通知。Note: The specifications are subject to change without prior notice.



小型实验机挤出设备 Small Laboratorial Extrusion Equipment

小型试验机挤出设备 Small testing extrusion line

上海金纬提供的小型试验机挤出设备，可完成挤出、流延、制片、拉伸、复合等挤出成型的加工实验。主要应用于各大化工院校、塑料研究所等科研机构的高分子材料的性能加工测试和高分子产品企业的研发部门的新产品开发以及普通塑料制品企业的定制产品打样工作等。

The small testing extrusion lines provided by Shanghai JWELL can meet the demands of extrusion, casting, sheet production, stretching and composite etc. processing test. These lines are used by some Chemical Colleges and Plastics Research Institutes to process and test the performance of the polymer material; It is also for developing new products or making samples and other application in plastic factory's research department.



单层或多层共挤流延膜生产线

Single Layer Or Multi-Layer Cast Film Extrusion Line

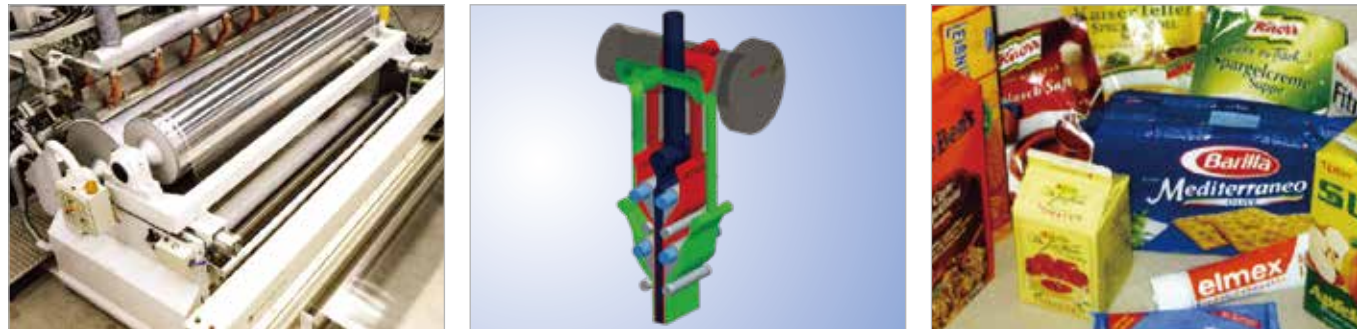

单层或多层共挤流延膜生产线 Single layer or multi-layer cast film extrusion line

主要用于生产CPP CPE EVA PVB 单层、多层光膜；CPP CPE EVA PVB 单层、多层压花膜；CPP CPE 透气膜。

Mainly used for producing CPP CPE EVA single, multi-layer flat film; CPP CPE EVA single, multi-layer embossed film; CPP CPE air free film;

PVB夹胶膜生产线 PVB flim extrusion line

主要用于生产安全夹胶玻璃用PVB中间膜。

It is for producing PVB and EVA film which used in the middle layer of laminated glass.

PVDF背膜生产线 PVDF flim extrusion line

主要用于生产水处理用PVDF膜、户外建筑用PVDF膜、锂电池用PVDF膜和太阳能电池背膜等特殊功能性薄膜。

This extrusion line is mainly used for producing the PVDF film for treatment of production water, outdoor buildings, lithium battery, and the back membrane of solar cell, other special film.

主要技术参数 Main technical specification

机组型号 Model	JW90/33, JW45/30	JW120/33, JW65/33	JW150/33, JW90/33
树脂 Material	PP-Homo均聚聚丙烯, PP-Copo共聚聚丙烯		
薄膜宽度 Film width	18-250 μm		
薄膜厚度 Film thickness	3层或5层 3 or 5 layers		
共挤结构 Coextrusion structures	1800mm	3000mm	4500mm
辊筒直径 Roller dia.	600mm	800mm	1000mm
设计线速度 Designed production speed	150m/min	180m/min	250m/min

备注：以上规格参数如有变更，恕不另行通知。Note:The specifications are subject to change without prior notice.

单层或多层淋膜涂覆复合生产线

Single Layer Or Multi-Layer Coating Film Extrusion Line



单层或多层淋膜涂覆复合生产线 Single layer or multi-layer coating film extrusion line

应用范围：纸塑复合、铝塑复合、塑塑复合、纸铝塑复合。

Application range : Paper-plastic compound 、Aluminum-plastic compound 、Plastic-plastic compound 、Paper-aluminum plastic compound

金纬产品主要有牛奶、液体无菌包装材料挤出复合生产线；高档数码相纸挤出流涎复合生产线；牙膏片材挤出复合生产线；预涂膜、护卡膜挤出流涎复合生产线；糖果、食品高阻隔包装材料挤出复合生产线；医药高阻隔包装材料挤出复合生产线；方便面淋膜复合生产线；纸杯纸、纸餐盒淋膜机以及单面淋膜、双面淋膜、单层挤出、双层共挤、三层共挤生产线等高品质设备。

JWELL coating film production lines, including milk, liquid asepsis packing film co-extrusion line, high-class digital printing paper extrusion and laminating composite production line, toothpaste sheet extrusion line, pre-coating film and card film extrusion and laminating composite production line, candy and food high barrier packaging material extrusion line, medicine barrier packaging sheet extrusion line, insant noodle coating film production line, papercups and paper food containers drench film machine, single or double sides coating film, single, double or three layers co-extrusion lines.

主要技术参数 Main technical specification

挤出机规格 Model	JW90/33, JW45/30	JW100/33, JW45/30	JW120/33, JW65/33
涂覆级树脂 Coating material	LDPE、LLDPE、PP、EVA、EAA、EMA、EMAA		
基材 Base material	BOPP、BOPET、BOPA、CPP、CPE、薄纸Paper、铝箔Aluminum Foil		
淋膜厚度 Coating thickness	单层single layer 5~30um, 共挤Co-extrusion 10-40um (误差error≤±3%)		
淋膜宽度 Coating width	1100mm	1300mm	1500mm
辊筒直径 Roller dia.	500mm	600mm	700mm
设计线速度 Design line speed	150m/min	180m/min	250m/min

备注：以上规格参数如有变更，恕不另行通知。Note:The specifications are subject to change without prior notice.

其它的塑料片材生产线 Other Plastic Sheet Extrusion Line

纵向拉伸生产线(MDO) Lognitudinal streching equipment extrusion line

纵向拉伸生产线(简称MDO)主要应用于PP、PE 锂离子电池隔膜; PP、PE 卫材透气膜; PP、PE、PET 热收缩包装行业等单向拉伸薄膜领域。

Lognitudinal strech equipment (short name is MDO) is mainly used for PP、PE lithium electric film; PP、PE breathable film; PP、PE、PET thermo-shrinkage packing industrial, etc single streching film industrial.



双向拉伸薄膜生产线 Bidirectional pull flim extrusion line

主要用于生产 BOPP BOPS BOPET BOPA 等通用包装薄膜和 PE 双向拉伸电池隔膜、PVDF 双向拉伸太阳能电池隔膜、双向拉伸微孔透气膜等特殊用途薄膜。

The machine is mainly used to produce BOPP, BOPS, BOPET, BOPA etc. packaging film and BOPE battery separating film, also for PVDF biaxially oriented solar film, biaxially oriented microporous breathable film, and other film for special application.



TPU片板生产线 TPU sheet extrusion line

TPU片材和薄膜主要有超透和压纹两种, 主要应用鞋材, 箱包, 医疗。防水, 透气, 绝缘, 反光, 镭射等方面

TPU sheet and film have two types, one is super-transparent, the other is embossed. They were mainly used in the field of shoe material, luggage, medical treatment, water proof, ventilation, insulation, reflect light, laser, etc

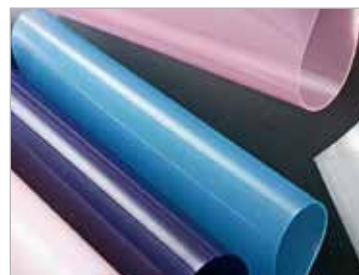

PE气垫膜(气泡膜)生产线 PE air bubble film extrusion line

可以替代发泡塑胶颗粒填充物之类的防护用品, 为电子产品、化妆品、音像CD等卖家的防护包装首选。

It's widely used in packing items to endure high vibration. PE air bubble film is completely suitable for the protection item made by foamed granules, so it is the first choice for packing electronics, cosmetics and vide CD products.

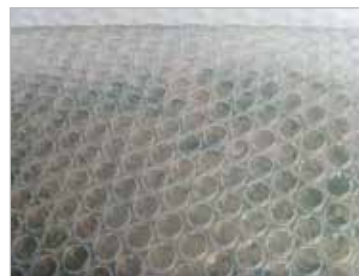

PVC结皮发泡、木塑发泡板材生产线 PVC skinning foaming、WPC foaming board extrusion line

PVC发泡板及木塑发泡板的应用于轮船、飞机、客车、火车车厢、顶蓬、厢体芯层、内部装潢用板和建筑物外墙板、内装饰用板、住宅、办公室、公共场所建筑物隔间、商用装饰架、无尘室用板、吊顶板、家庭厨柜、吊柜和家居。通过油漆印刷、贴膜和热压设备, 可以生产各类仿木制品。

Transportation industrial: Ship, plane, bus, chamber of train, roofing, core layer, inner decoration board. Construction and decoration industrial: outer wall board, inner decoration board, housing, office, public construction board, furniture. cupboard, roofing. Adopting printing, film coating and thermo-embossing equipment, will get all kinds of emulational wooden product.



PE蓄电池隔板生产线 PE battery separating plate extrusion line

隔板蓄电池的重要组成, PE隔板是蓄电池隔板的换代产品, 随着我国汽车行业发展及普及, PE隔板市场将进一步扩大。

It is an important part of battery. PE separating plate is a new style of battery separator. With the development of car industry in China, the market share of PE separating plate will be greatly increased.



单螺杆造粒挤出生产线 Single screw pelletizing extrusion line

采用特殊的螺杆设计及不同配置, 适用于生产PP、PE、PET、PS、ABS、PA、PVC、PC、POM、EVA、PMMA等多种塑料的再生及混色造粒。

This pelletizing extruder has the special screw design and different configuration, it is suitable for the recycling and pelletizing of raw materials such as PP, PE, PET, PS, ABS, PA, PVC, PC, POM, EVA, PMMA and the pelletizing of the raw materials with different colors.

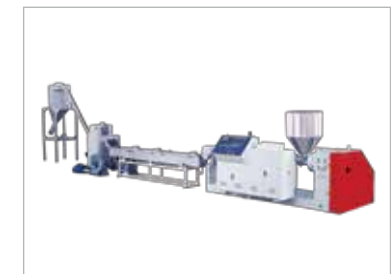

塑料土工格栅生产线 Plastic geogrid extrusion line

产品广泛应用于水利、公路、铁路、煤矿、建筑等工程领域。如用于建坝、护坝、护坡, 防汛防洪网笼, 高速公路、铁路、路基加固, 挡土墙护网、矿井顶网, 由于在工程应用中表现出的优越性能, 以及产品低成本、高效率的特点, 市场前景广阔。

It is widely used in irrigation, highway, railway, mine and building project, for example it's used to build dam, protect dam and slope, protect network of preventing flood, fix the roadbed and etc. The product has a high perspective among the markets because of its effective features.

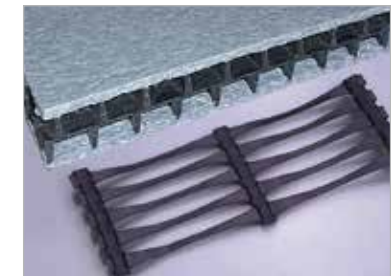

钢材钢卷防锈用PP、PE塑料包装板材生产线

PP, PE plastic packing plate for rust prevention of iron and steel extrusion line

钢卷包装用塑料端护板。塑料保护板、端护板、内外护角圈、端护圈、包装盒、垫片等。金纬也可以提供钢材包装专用三层共挤PE/PP发泡板材生产线。

protection board for steel roll packing. Plastic protection board, terminal protection board, inside and outside angle protection ring, terminal protection ring, packing case, gasket and so on. Jwell can provide three-layer co-extrusion PE/PP foaming board production line only for steel packing.



PP、PE、PVC 蜂窝板生产线 PP, PE, PVC beehive plate extrusion line

应用: 汽车车身、铁路、火车箱体、船舶、化学品储藏罐、以及建筑、高档房屋的装修、隔板、身体保护用品等诸多领域。

It has advantages of low weight, high intensity, heat preservation, sound insulation, anti-erosion, nontoxic and deleterious, and it has the features of energy absorption, vibration decreasing and absorption when impacted.

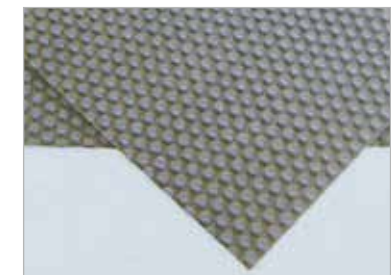

集中供料系统 Feeding System

集中供料系统是为塑料挤出车间的塑料产品生产而设计的，实现了不间断无人化连续成型作业。可根据需要改变原料品种、多颜色材料的组合使用方式，实现配方工序的自动化。系统能够以全自动方式组合原料成份及状态，能够对所有供料设备的控制，并防止了储料仓内阻塞现象的发生，通过设置中央监控台实现全自动化。

Material centralized feeding system was designed for the plastic product extrusion plant, which can keep working automatically. It can change the raw material and color masterbatch, making up the formulation automatically as per the need of production. The system will make the material components and state automatically, being easy for controlling the material feeding of all production lines, and protecting the material block in the hopper, realizing material feeding automatically by the data setting in the central controlling panel.

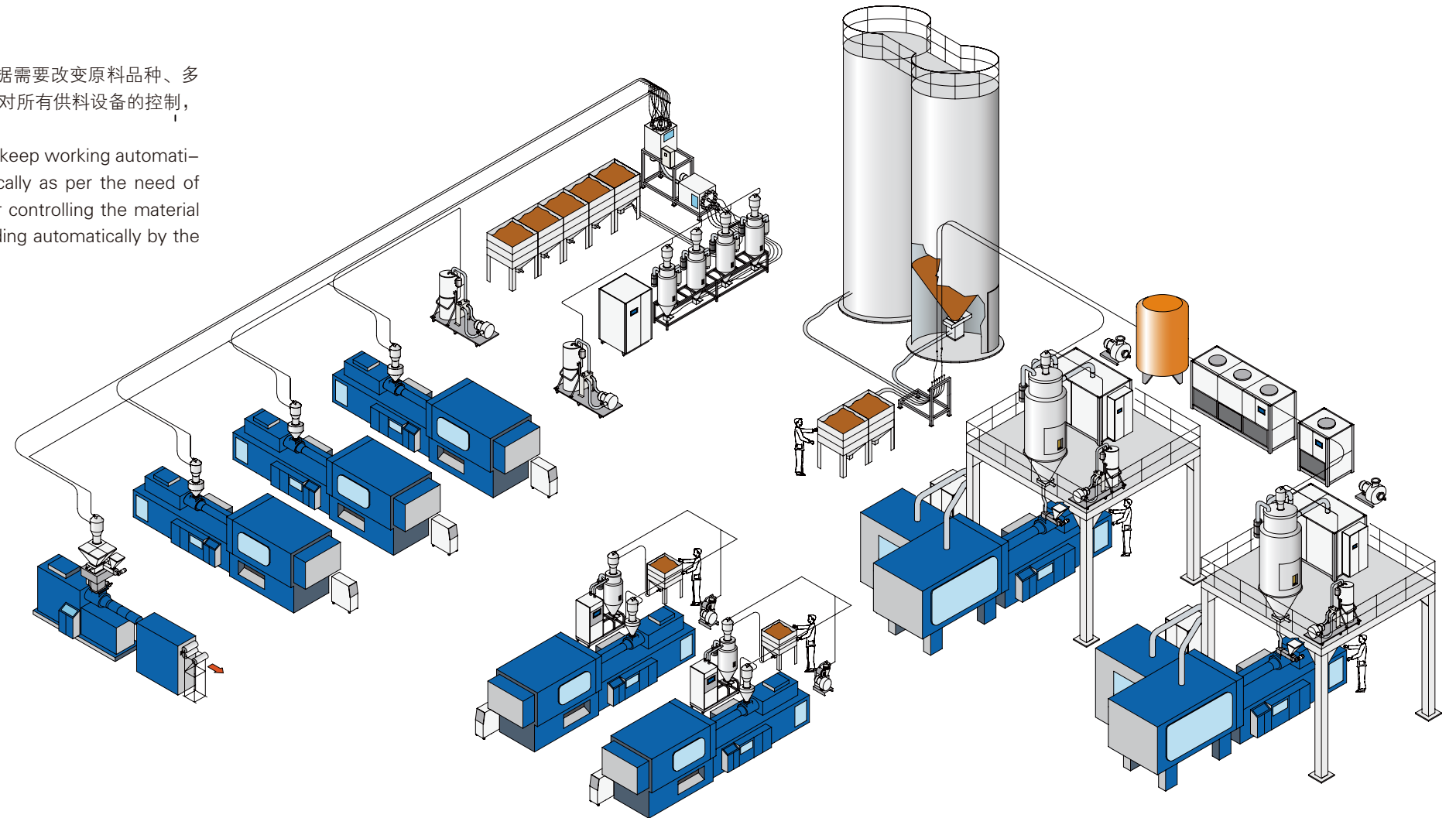

流程: 原料→储存→计量→干燥→输送→使用

Process: material→storage→metering→drying→feeding→use

特点: 高效、节能、个性化、现代化工厂形象

Features: efficient、energy saving、individuation、image of modern forming factory



计量
Metering



干燥
Drying



配管
Piping



中央气泵
Central air pump



输送
Conveying



脉冲集尘器
Pulse dust collector

相关公司产品链接 Linkage Of Relating Auxiliary Equipment



自动换网器和液压站
Hydraulic Screen Changer



失重式喂料装置
Dosing System



在线测厚仪
On-line Continuous Measurements



冷水机
Water Chiller Unit



挤出机
Extruder



各类镜面辊筒
All Kinds of Mirror Rollers



模具和分配器
T-die And Feedblock



计量泵
Metering Pump



破碎机
Crusher

挤出机械物联网+智能制造解决方案

以服务流程优化驱动，融合信息化管理手段，输出金纬机械的服务体系业务流程，提供基于工业互联网的智能服务平台，提高金纬机械为客户提供增值服务的能力，支持金纬机械卓越运营，增加客户粘性。构建企业级工业互联网平台，提供物联与呈现的应用。提供服务管理系统，全面管理金纬机械的服务流程。

Service process optimization drive, integrate information management method, provide Jwell machinery service system business processes, providing intelligence service platform based on the Internet industry, improve the ability of Jwell machinery value-added services for customer, support Jwell machinery excellent operation, increase customer loyalty. Build enterprise-level industrial Internet platform, provide the application of the thing link and presentation. Provide the service management system, manage the service flow of Jwell machinery.



设备总览
Equipment overview



维修和保养召请
Repair and maintenance calls



远程监测
Remote monitoring



实时工况
Real-time operating status



周边情况
Surrounding circumstances



作业情况统计
Working status statistics

Plastic Machinery Fully Integrated Automation + Internet Of Things Control System Solutions

基于MES系统平台，实现车间生产管理的信息沟通平台，并向智能化方向发展。

Based on the MES system platform, the information communication platform of workshop production management is realized and move toward the intelligent direction



企业风采：品质管理 技术研发 国际交流 客户服务 员工培训

Quality Control Technology Research International Communication Customer Service Staff Training

